

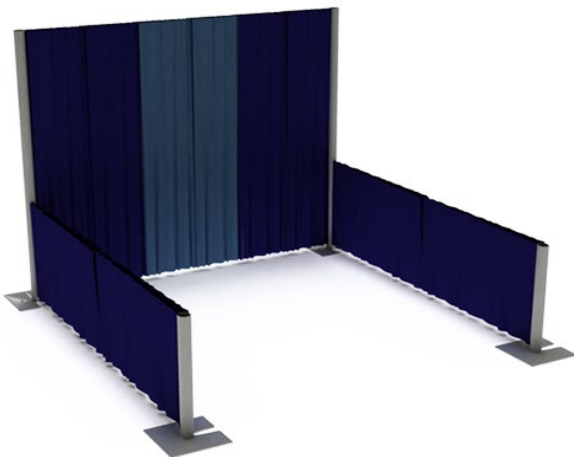

STANDARD OR "INLINE" (Instead of Linear Booth Spaces)

Any booth that shares a common back wall and/or side with other exhibits and only one side exposed to aisle. These booths can be purchased in a row to make a 10x20, 10x30, 10x40 etc. if the exhibitor abides by the rules below:

- Max height = 8'
- No end caps are allowed
- All display material over 5' may not extend farther out than 5' from the back of the booth space
- Exhibitors are required to provide flooring for the totality of their purchased space

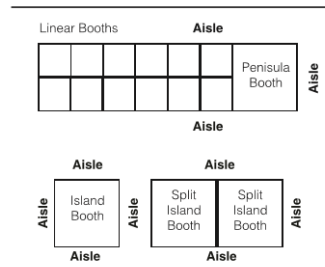
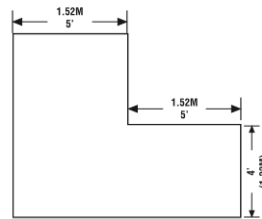
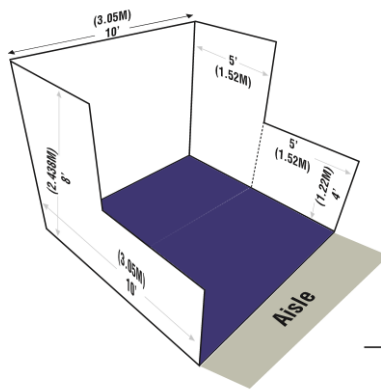
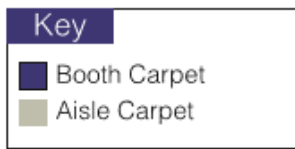



PERIMETER BOOTH SPACES

Perimeter booth spaces are located along the exhibit halls perimeter walls. These booths can be purchased if the exhibitor abides by the rules below:

- Max height = 12'
- Hanging Signs: Not permitted
- Back walls and side walls that are visible must be finished
- Tents are allowed in perimeter booths ONLY
- Exhibitors are required to provide flooring for the totality of their purchased space

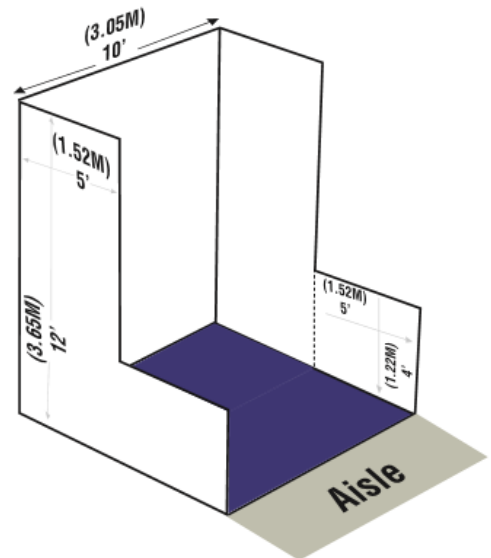
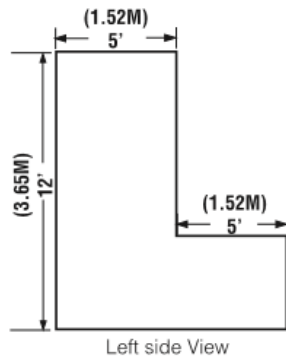
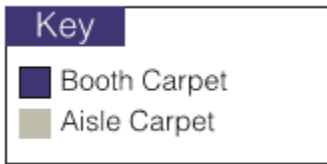



MINI ISLAND BOOTHS

A Mini Island booth is a narrow island type booth space comprised of one more or 10 ft-by-10 ft booths. These booths can be purchased in a row to make a 10x30, 10x40 etc. if the exhibitor abides by the rules below:

- Exhibitors are **required** to provide flooring for the totality of their purchased space
- No drape will be provided or permitted
- Mini Island (Multi-Story) are not permitted: One level only
- Max height = 12'
- Must be accessible from all 4 sides
- Hanging signs are allowed provided they do not extend into the aisle on any side. Max height for hanging is 20'.
- Back walls and side walls that are visible must be finished
- Any unfished sides are subject to revisions onsite at the exhibitor's expense
- Stand drawings must be submitted in advance for approval to standdrawings@printingunited.com by August 1, 2025.

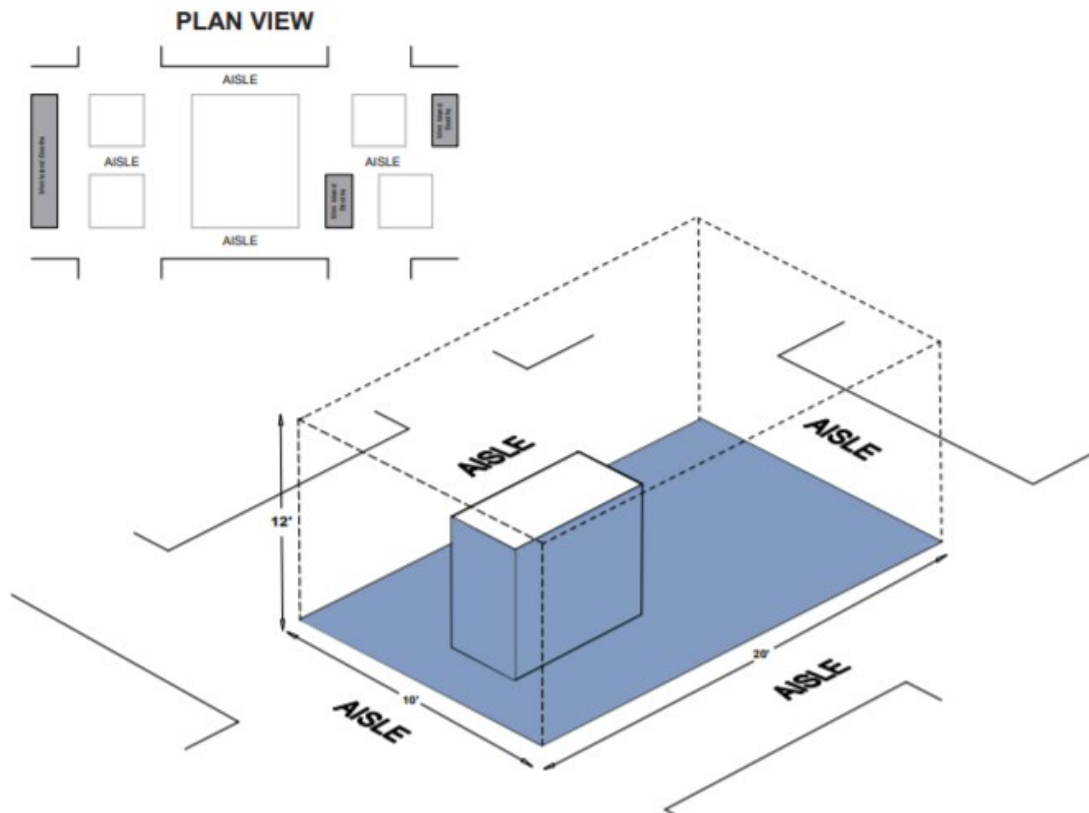

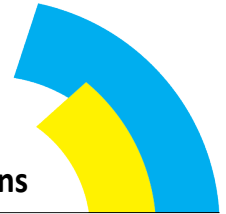

ISLAND BOOTHS

An Island booth is any size booth exposed to aisles on all four sides. These booths can be purchased if the exhibitor abides by the rules below:

- Exhibitors are required to provide flooring for the totality of their purchased space.
- Max height = 20' (Including hanging sign) *unless a sponsor.
- Must be accessible from all 4 sides
- Hanging signs are allowed
- Stand drawings must be submitted in advance for approval to standdrawings@printingunited.com by August 1, 2025.

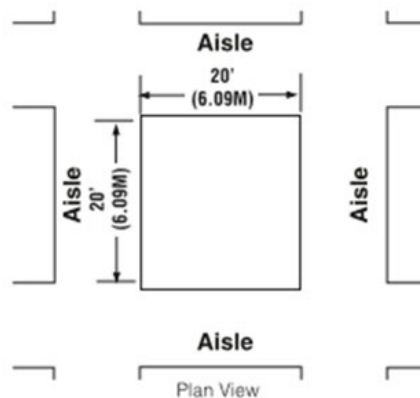
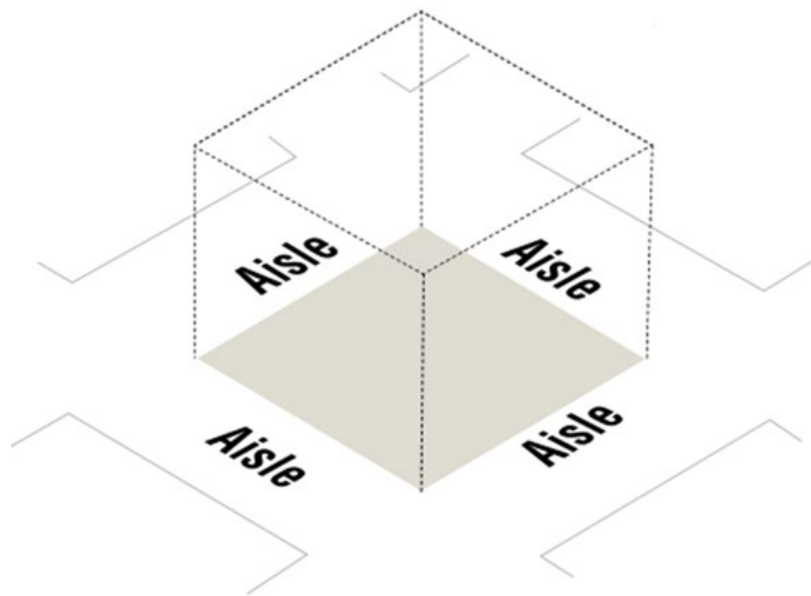



MULTI-STORY BOOTH

A Multi-story booth is a booth where the display fixture includes two or more levels. These booths can be purchased if the exhibitor abides by the rules below:

- Max height = 20' (Including hanging sign)
- In many cities, a Multi-storied booth requires prior approval by the exhibit facility, and/or fire marshal, as well as show management because it is considered to be a “structure” for building purposes.
- Stamped engineer drawings should include rise and run of stairs as well as load levels. Please submit physical copies including rise and run of stairs and load capacity limits to the venue for Fire Marshal and Engineer approval to:

Nila Kushner, CMP

Senior Event Manager | Event Management

ORANGE COUNTY CONVENTION CENTER

Direct: (407) 685- 5813 | Mobile: (321) 263-7604 | Fax: (407) 685- 9866

Email: nila.kushner@occc.net

- Stand drawings must be submitted in advance for approval to standdrawings@printingunited.com by August 1, 2025.
- Fire extinguisher(s) and smoke detector(s) will often need to be included in the overall design

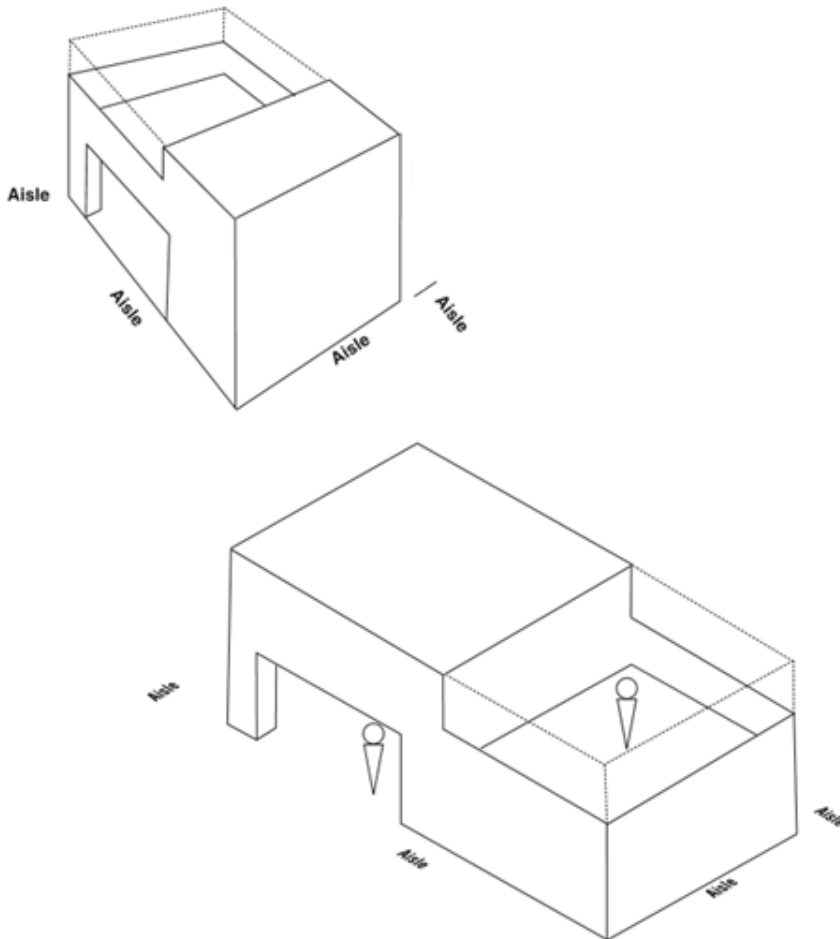

MACHINERY

All machinery and other large products must be set back from the aisles a MINIMUM of 12 inches (0.30m) for safety. Exhibitors are required to place equipment in such a manner that printed samples do not overflow into the aisles.

**Applies to all booths planning to exhibit machinery of any kind.

SPONSOR HANGING SIGN HEIGHT VARIANCE

Title Sponsors: Maximum height limit is 27'H to the top of the sign

Diamond Sponsors: Maximum height limit is 27'H to the top of the sign

Platinum Sponsors: Maximum height limit is 25'H to the top of the sign

Gold Sponsors: Maximum height limit is 23'H to the top of the sign



** Applies to Island, Mini Island, Multi-Story, Split Island and Peninsula booths

REQUIREMENTS FOR ALL EXHIBITORS

- Exhibitors are **required** to provide flooring for the totality of their purchased space
- Vinyl or adhesive graphics are only allowed for flooring if the venue has been sent a sample in advance and approval from the venue has been granted in writing
- No end caps are allowed
- Tents are allowed in perimeter booths ONLY
- Balloons are NOT permitted in any booth space
- Hanging signs are only permitted in certain booth types and hanging height varies
- Back walls and side walls that are visible must be finished

U.S. Americans With Disabilities Act (ADA)

In the U.S., all exhibiting companies are required to be in compliance with the U.S. Americans with Disabilities Act (ADA), and are encouraged to be sensitive, and as reasonably accommodating as possible, to attendees with disabilities. Information regarding ADA compliance is available from the U.S. Department of Justice ADA Information Line (800) 514-0301, and from the ADA website at www.ada.gov. Some examples of how to design an exhibit for ADA compliance:

- Make exhibits wheelchair accessible by ramping raised exhibit flooring without extending a ramp into the aisle. Note: a standard wheelchair ramp should have a grade no steeper than 1:12. This means that for every inch of rise (change in height), there should be 12 inches of run (change in length). Ramps should have a minimum width of 36 inches.
- Ramp the entry or use hydraulic lifts to trailer exhibits.
- Avoid double-padded plush carpet to ease mobility device navigation.
- Provide the same attendee experience on both levels of a two-story exhibit.
- Offer a signer or other auxiliary hearing-impaired apparatus for sound presentations or have a printed copy of the presentation available.
- Run an audio presentation for people with sight problems.
- Arrange touch screen displays at a height to accommodate a person sitting in a wheelchair. To avoid potential fines by the U. S. Department of Justice, exhibitors must adhere to the ADA rules. Exhibits are not exempt from ADA compliance.

Structural Integrity

All exhibit displays should be designed and erected in a manner that will withstand normal contact or vibration caused by neighboring exhibitors, hall laborers, or installation/dismantling equipment, such as forklifts. Displays should also be able to withstand moderate wind effects that may occur in the exhibit hall when freight doors are open. Refer to local building codes that regulate temporary structures.